



Probulator®

by **tecMATE**

Easy back-probing of wiring harness connectors for electrical troubleshooting. Special design allows electrical contact in all types of wire harness connectors without damaging the cable shroud or connector body.

Accès facile pour mesures au sein-même des blocs de connexion. La forme spéciale permet un contact électrique franc sur tout type de connecteur sans endommager ni celui-ci ni la gaine de câble.

Acceso fácil para medidas dentro de bloques de conexión. La forma especial permite un buen contacto eléctrico por todo tipo de conector sin dañar el mismo ó el revestimiento del cable.

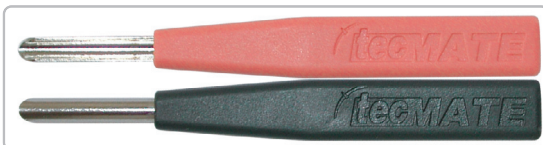
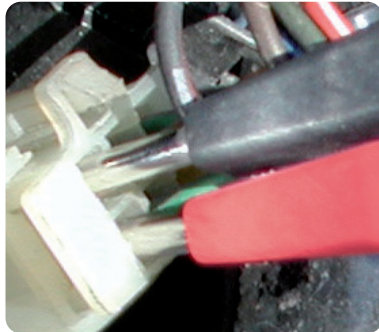

2 sizes to suit all popular cables (see back)
2 tailles conviennent tous cables populaires (regardez verso)
2 tamaños apropiado todos cables populares (véase detrás)

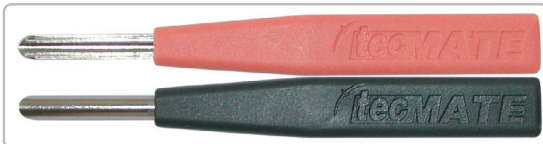

TM-99

Probulator®

www.tecmate.com
www.tecmate-int.com

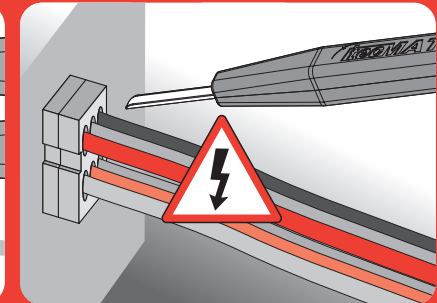
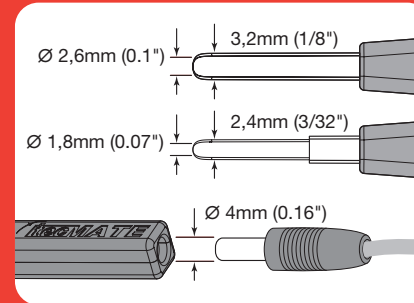
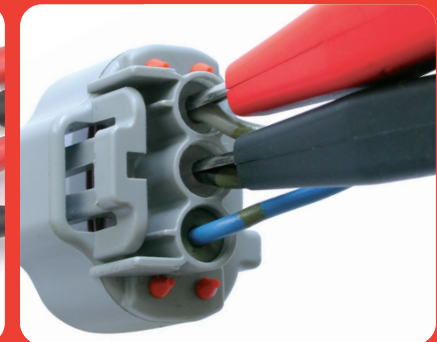
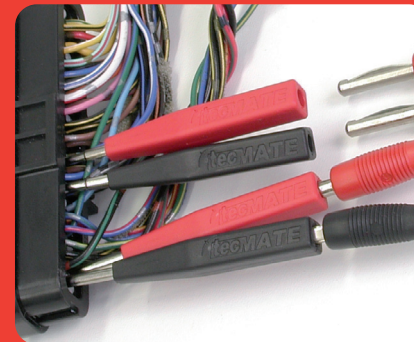

IMPORTANT!

To prevent damage to probes and connectors, avoid excessive force when inserting.

Garder contre des dégats aux sondes / blocs connecteur en évitant la force excessive en insérant les sondes.

Guardar contra daños a las sondas/bloques conector evitando la fuerza excesiva insertando las sondas.

Um Beschädigung der Prüfspitzen und der Stecker zu verhindern, vermeiden Sie übermäßige Kraft beim Einsetzen.

Per prevenire danni alle sonde ed ai connettori, evitate la forza eccessiva mentre state inserendo le sonde

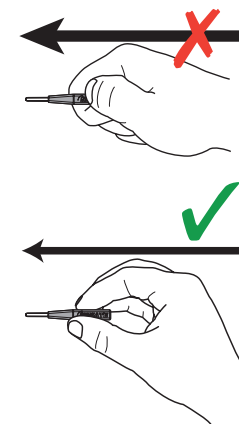

TecMate International, B-3300 Tienen, Belgium, www.tecmate-int.com
TecMate North America, Oakville ON L6H 2K9, Canada, www.tecmate.com

MADE IN CHINA

0712 0706